



ELIT®

NÅR FAGKUNNSKAP & KOMPETANSE TELLER

BRUKERMANUAL ELIT 365, 364, 364B



Sann RMS strømtang
WWW.ELIT.NO

INNHOOLD

Strømtangserie: ELIT 364, 364B, 365

Sikkerhetsinformasjon	4
Knappenes funksjon	5
Hurtigguide for bruk av målefunksjonene	6
Engelsk brukermanual	12

Sikkerhetsinformasjon:

- CE, TUV/GS sertifisering: EN61010-1:2010, EN611010-031:2015, EN61010-2-032:2012, EN61010-2-033:2012, «Sikkerhetskrav for elektronisk måle- og laboratoriestyr»
- EN61326-1:2013, EN61326-2-2:2013, «EMC krav for elektronisk måle- og laboratoriestyr»
- CAT IV 600V overspenningskategori. Dobbelisolert. Forurensningsgrad 2.
- Før bruk les nøye gjennom brukermanual, og bruk instrumentet som anvist.
- Ikke bruk skadet måleinstrument eller tilbehør. Skift ut skadet utstyr før bruk. Ikke måle på spenninger eller strømmer høyere enn maksimalt angitt i manualen.
- Ikke bruk instrumentet med deksler fjernet. Koble fra måleledninger før skifte av batteri.
- Hvis batterisymbol lyser må batteri skiftet for å sikre målenøyaktighet og korrekt visning.
- Sett rotasjonsbryter i korrekt posisjon før måling startes. Ikke vri på bryteren under måling.
- Ved måling hold fingrene bak sikkerhetskrage på instrument og målespiss, ikke berør metallkomponenter.
- Koble måleledningene fra målepunkt etter måling er fullført.
- Erstatt måleledninger og prober med korrekt sikkerhetskategori: CAT IV 600V/CAT III 1000V
- Ved måling på spenninger over 30V AC eller DC: korrekte sikkerhetsregler må følges.
- Ikke bruk Lav-passfilteret for å kontrollere spenning før arbeid, benytt normal spenningsmåling.
- Ikke bruk LavZ funksjonen i kretser som kan skades av lav impedans (300k Ohm)
- Ikke bruk instrumentet i høy temperatur og/eller høy luftfuktighet. Ikke oppbevar instrumentet i områder med høy luftfuktighet da dette kan gå utover prestasjonen til enheten.
- Ikke endre på intern kobling i instrumentet. Service skal utføres av ELIT AS.
- Rengjør instrumentet med en lett fuktet klut og mild såpe.
- Se engelsk del av manual for komplett informasjon

Knappenes funksjon:

- OMRÅDE:** Trykk «Område» knappen en gang for gå fra automatisk-områdevalg til manuelt områdevalg. Hvert nye trykk på knappen endrer måleområde. Aktiv ved måling av strøm, spenning, resistans, kapasitans og frekvens. (600,0mV → 6,0000V → 60,000V → 600,00V) Hold knappen inne i 2 sekunder eller mer for å gå tilbake til Automatisk områdevalg.
- MAX/MIN:** Trykk en gang og MAX vises i display. Displayet vil nå vise maksimal målte verdi, trykk en gang til for visning av laveste målte verdi(MIN). Flere trykk veksler mellom disse målingene. Hold knappen inne i 2 sekunder for å gå tilbake til normalt målemodus.
- REL/NULL:** Ett trykk på knappen tar deg inn i manuelt områdevalg, i displayet vises ett trekant-symbol. Målt verdi i øyeblikket man trykket vil bli brukt som referanse og avvik fra denne verdien vises i displayet.
-Ved måling av DC strøm benyttes knappen til å nulle ut verdien i displayet før måling.
- HOLD:** Ett trykk på denne knappen vil fryse måleverdien i displayet, og «H» vises i displayet. Trykk en gang til for å gå tilbake til normalt målemodus.
- LYS AV:** Skur av funksjonen for automatisk bakgrunnsbelysning. For å aktivisere lyset igjen skru instrumentet av og på med rotasjonsbryteren.
- V+A/INRUSH:** (kun ELIT 365)
I DC strømmodus: Aktiviserer dobbelt display DC ampere i hoved-display og DC spenning i sekundær-displayet. Trykk igjen for å gå til normalt målemodus.
I AC strømmodus: Samme som DC ved kort trykk på knappen.
Trykk og hold i 2 sekunder for INRUSH funksjon: Hoved-displayet viser startstrøm(inrush) og sekundær-displayet viser normalt strømtrekk. Trykk og hold i 2 sekunder for å gå tilbake til normalt modus.
- HZ%:** (kun ELIT 364 og 364B) Trykkes for å veksle mellom visning av frekvens eller pulsbredde
- VELG:** Trykkes for å komme til underfunksjoner merket med blått på hvert område av rotasjonsbryteren. Holdes to sekunder for mytorrotasjon.

Hurtigguide for bruk av målefunksjonene.

Måling av strøm

Sett rotasjonsbryter til A- området og klyp tangkjeftet rund AC-strøm-lederen som skal måles, plasser ledere i senter av tangkjeft for best nøyaktighet. Mål kun en fase om gangen. Les ev SANN RMS strømverdi i displayet.

Inrush/startstrøm (kun ELIT 365): Skru av motor, plasser tangkjeft rundt leder som skal måles. Aktiviser Inrush modus, tangen venter nå på signal (minimum 6AAC) start motoren og startstrømmen vises i hoved-displayet, kombinert med normal driftsstrøm i sekundær-displayet. Startstrømmen er de første 100mS SANN RMS verdi fra triggerpunktet som bildet viser:

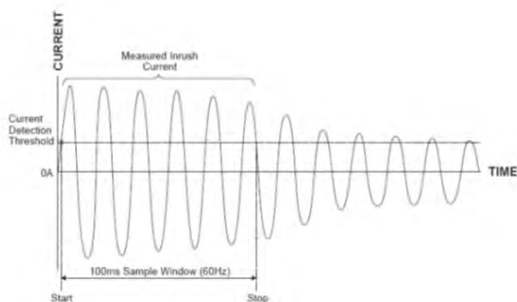
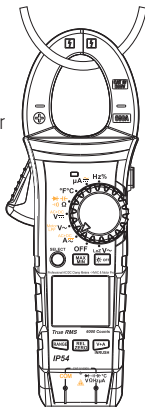

Måling av DC strøm (kun ELIT 365): Sett rotasjonsbryteren i A- området og trykk på VELG for DC modus. Trykk REL/NULL for å nulle ut verdi i displayet og måle som beskrevet i AC modus.

Måling av spenning.

Koble ledningene til COM og V terminalene. Sett rotasjonsbryteren til V-. Koble målepissene i parallell over AC spenningsforsyningen som ønskes målt. Les av verdi i SANN RMS.

Sett rotasjonsbryteren til LavZ- posisjon for måling med lav inngangsimpedans (300k OHM). Dette vil belaste kretsen og fjerne eventuelle spøkelsspenninger.

Aktiviser Lav-passfilter (kun ELIT 365) for måling på invertere og frekvensomformere:

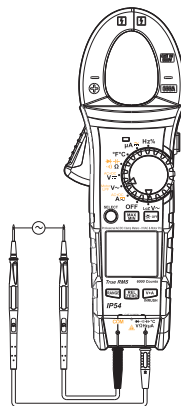

Sett rotasjonsbryteren til V- for måling av DC spenning. Koble målepissene i parallell til DC spenningsforsyningen og les av spenningen.

Måling av mikro ampere (μA)

(kun ELIT 365 og 364B)

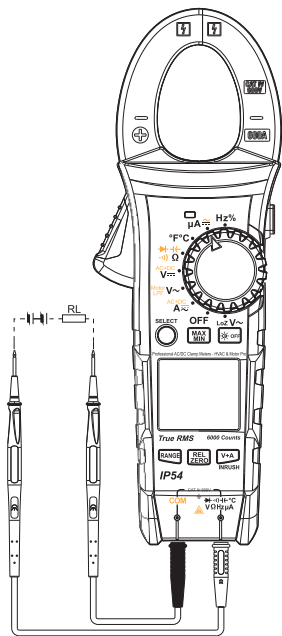

Sett rotasjonsbryteren til μA området og velg AC eller DC signal med VELG knappen. Koble måleledningene til COM og $\mu\text{A}/\text{V}$ terminalen. Koble målespissene inn i serie med kretsen og les av verdien.

Måling av resistans, summer, diode og kapasitans

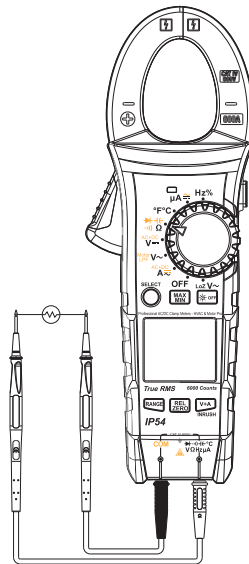

Resistans: Koble ledningene til COM og Ω/V terminalene og sett rotasjonsbryter på Ω (kap./diode/sum.) Koble målespissene i parallell over resistansen det ønskes målt på og les av verdien.

Summer: Trykk VELG knappen en gang for summer-funksjon. Koble til kretsen som ønskes målt. Er motstanden under 10 ohm vil instrumentet pipe, er det over 50 ohm vil det ikke pipe. Resistansverdien kan leses av i displayet.

Diode: Trykk VELG knappen så diodesymbolet vises i display (eget område for rotasjonsbryter på ELIT 364) Koble målespissene i parallell over dioden det ønskes målt på og les av verdien (normalt 0,5-0,8V) COM -terminal er minus og Ω/V -terminal er pluss.

Kapasitans \kondensator: Trykk på VELG til symbolet for kondensator vises i displayet (eget område for ELIT 364B). Koble målespissene i parallell over kondensatoren som ønskes målt og les av verdien. Ved stor kapasitans kan det ta lang tid før stabil verdi vises.

Måling av frekvens

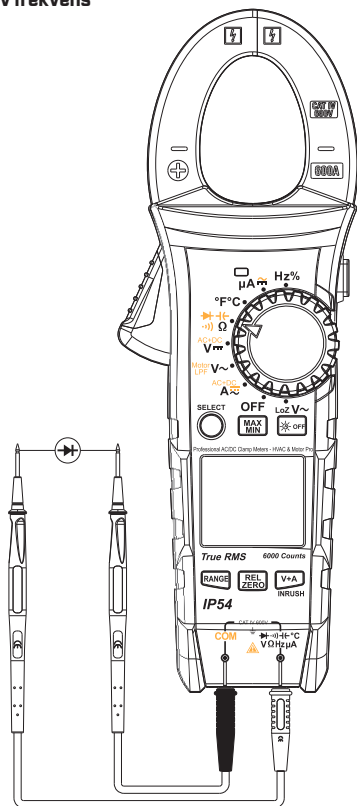

Koble ledningene til COM og Hz(V) terminalene. Sett rotasjonsbryteren på Hz, og koble til målespissene på signalkilden som ønskes målt. Måling av frekvens er også mulig ved området for spenning og strømmåling. Trykk da på Hz knappen, eller les direkte av i sekundær-displayet der dette er tilgjengelig.

Måling av temperatur

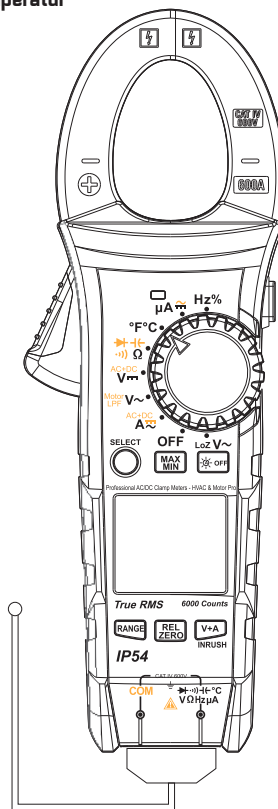

Sett rotasjonsbryter til °C/°F, koble temperaturadapteret til 4mm terminalene. Før tuppen på trådføleren bort til elementet som ønskes målt og les av temperaturen i displayet. Trykk på VELG for å veksle mellom Celsius og Fahrenheit.

Preface

Dear Customers:

Thank you for purchasing this brand new ELIT instrument, for the purpose of using the instrument properly, we ask you to read this instruction manual carefully and thoroughly before putting this instrument into service, especially the sections related with “Safety Precautions”. After you have read this instruction manual thoroughly, we suggest you place this instruction manual at a convenient location for future reference.

Limited Warranty Liability

ELIT AS will guarantee this product is free from any defect in material and process within one year from the date of purchase. This warranty is not applicable to fuse, disposable batteries, or any damage resulted from any accident, negligence, misuse, retrofitting, contamination, misoperation or handling. The dealer shall not be entitled to give any other warranty in the name of ELIT.

If warranty service is required within warranty period, please contact your nearest service center authorized by ELIT to obtain authorized information on return of the product; then send the product together with the description of problems to that service center. This warranty is the only compensation that you can obtain. Otherwise,

ELIT will not provide any expressed or implied guarantee, such as the implied guarantee to certain specific item. Meanwhile, ELIT will not be responsible for any special incidental or indirect damage or loss that is caused by any reason or speculation. As some areas or countries do not allow to implied guarantees and collateral or limit incidental or subsequent damage, above limitation of liability and stipulation may not applicable to you.

Content

I. Overview-----	14
II. Unpacking Inspection-----	14
III. Safe Operation Rules-----	15
IV. Features-----	18
V. Electrical Symbols-----	20
VI. Comprehensive Specifications-----	21
VII. Overall Configuration-----	22
VIII. LCD Display-----	23
IX. Knobs-----	26
X. Buttons-----	29
XI. Operating Instruction for Double Display Function-----	32
XII. Operating Instruction for Measuring-----	34
XIII. Technical specifications-----	58
XIV. Maintenance and Repair-----	67

I. Overview

ELIT professional clamp meter series is three-proofing digital clamp meters specially designed for professional industrial users. The industrial design of this series is rugged and durable, and capable of withstanding the impact from 2 meters' fall-down. The water proof rating is up to IP54; therefore, it can be used in environment with water splashing or much more dust. The whole series is configured with LoZ (Low impedance input) AC voltage tap position, which is capable of testing the false voltage; auto backlight function can be used continuously under the circumstance of emergency power outage. ELIT 364B and W254/365 are also provided with MOTOR test function, allowing to directly test the phase sequence of three phase AC motor by means of the probe. The series is much more in compliance with the CAT IV 600V safety level, and certified by the German GS institution.

This Instruction Manual contains relevant safety information and warnings, read relevant contents carefully and strictly follow all warnings and precautions.

II. Unpacking Inspection

Take out the meter after unpacking, please inspect whether following accessories are missed or damaged or not, if any missing or damage is found, contact your supplier without any delay.

1. Instruction Manual----- 1 copy
2. Probe----- 1 pair
3. Point K type
(nickel-chromium ~ nickel-silicon)
thermocouple one 364B, W254, 365



III. Safe Operation Rules

A) Safety certification

1. CE, TUV/GS certification: EN 61010-1: 2010 EN 61010-031: 2015 EN 61010-2-032: 2012 EN 61010-2-033: 2012 "Safety requirements for electrical equipment measurement, control laboratory use";
2. EN 61326-1:2013, EN 61326-2-2:2013 "Electrical equipment for measurement, control and laboratory use-EMC requirements"
3. CAT IV 600V, safety standard of pollution grade II and double insulation.

B) Prior to operation, read thoroughly the section "Safety operation rule", for the purpose of preventing electric shock or personal injury, carry out operation by following the guide below:











1. Carry out operation in accordance with the instructions in this manual, otherwise the protective measures for the meter may become invalid.
2. Do not use any damaged meter. Before using the meter, check the case of the meter for any crack or missed plastic part, special attention should be paid to the insulation around the joint.
3. Before putting the meter into operation, confirm that the battery cover has been closed and clamped. Before opening the battery cover, remove the test leads from the meter.
4. Inspect whether the insulation of the test leads is damaged or there is any exposed metal or not. Check whether the test leads are conductive or not. In case any damage with the conductor, use the meter only after replacement.
5. Do not measure any voltage or current which is higher than the allowable input value, when it is impossible to determine the range of the value to be measured, the function range switch should be set to maximum position. Before carrying out the

- on-line test for resistance, Diode or circuit on/off, all power supplies in the circuit should be turned off in advance, and all capacitors should be discharged, otherwise the inaccurate measuring result may be caused.
- In case the cover is removed or the cover is opened, do not use the meter.
 - Liquid crystal display shows “”symbol ELIT 364B or “”symbol 364, 365, W254 , replace the batteries timely to guarantee the measurement accuracy. Type 1.5 V AAA batteries should be used for supplying power for the meter, and care should be taken to install the batteries correctly.
 - The range switch should be set to a correct measuring position.
 - It is strictly forbidden to change the position of the range switch during the measuring to prevent the meter from being damaged.
 - When carrying out measuring, keep in mind not to extend your fingers over the hand-stopping location of the probes, do not touch any exposed conductor, connector, unused input terminal or the circuit under measuring to prevent electric shock.
 - After completion of each measuring operation, disconnect the probes from the tested circuit.
 - Replace the probes with same grade of CATIII1000V /CATIV600V or more probes.
 - If the voltage to be measured is DC 30 V or AC 30 Vrms, due care should be taken to avoid electric shock!
 - Do not use the low pass filter option to verify whether there is any hazardous voltage or not, as there is a possibility that the voltage may exceed the indicated value. First, measure the voltage under the circumstance that the filter is not connected to detect whether there is hazardous voltage or not. Then, select the filter function.
 - Do not use LoZ mode to measure the voltage in the circuit that may be damaged by the low impedance (300 k Ω) of this mode.
 - Do not use in high-temperature and high-humid environment, especially do not store the meter in moisture environment, as the performance of moistened meter may become degraded.
 - Do not modify the internal wiring of the meter randomly so as not to damage the meter and jeopardize the safety!
 - When carrying out maintenance, please use wet cloth and gentle cleanser to clean the case of the meter, do not use lapping compound or solvent!



IV. Features

- 1) Fully enclosed, IP54 ingress protection,
- 2) Capable of withstanding fall-down from 2 meters' height,
- 3) Large LCD dual mode reading display, 6,000 counted dual slope analog-to-digital converter
364, 364B conversion rate of 3 times/second, 365, W254 conversion rate of 5 times/second),
- 4) Full function misoperation prevention, enabling to sustain lightning impulse voltage of 8kV and more.
- 5) True Root Mean Square (TRMS) AC voltage and current can measure the non-linear signal precisely.
- 6) AC+DC measurement mode (AC is combined with DC) is defined as $\sqrt{a_c^2+d_c^2}$ (365, W254)
- 7) Available to measure alternating current up to 600A (full series) and direct current (365, W254) frequency response is 40 Hz to 400 Hz.
- 8) LOW PASS FILTER guarantees to precisely measure the voltage and the current (365, W254) of the variable speed driver (VSD).
- 9) MOTOR TEST three phase rotation test can identify the phases of the power supply (364B, 365, W254)
- 10) LoZ voltage measurement, which provides low impedance along the conductor circuit to solve the problem of false voltage measuring.
- 11) The measurement range of capacitance for motor start capacitance or elements is 60.00 mF.
- 12) There is a special function measuring as MAX, MIN, relative value, data holding and etc.
- 13) Manual and auto selection range allows maximum flexibility.
- 14) Auto backlight function turns on and off the backlight adjustment automatically according to the intensity.
- 15) It is possible to simultaneously measure the voltage and current so as to monitor the voltage while in current mode. (Only for 365, W254)
- 16) Surge current measurement enables to simultaneously measure the starting current of the motor and the stable operating current after starting up (only for 365, W254).
- 17) Celsius and Fahrenheit measurement (364B , 365, W254).

V. Electrical Symbols

Symbol	Meaning
	Double insulation
	Grounding
	Warning hint
	AC (Alternating current)
	DC (Direct current)
	Low battery in the unit
	AC (Alternating Current)/DC (Direct Current)
	Do not dispose this product as unclassified urban waste.
	High pressure alarm
	In compliance with EU directive
	Reviewed and approved by TÜV Product Services
CAT IV	IEC measurement category IV-CAT IV(CAT IV: The design of the device enables the device to subject to class 1 power rating, such as the transient voltage generated by kilo-watt-hour meter, overhead lines or downstream facilities.

VI. Comprehensive Specifications

1. The overload protection voltage between various input terminals and grounding is 1000V
2. Maximum display: 6000 bits, ELIT 364, 364B upgrades 3 times per second, 365, W254 upgrades 5 times per second. Over-range display "OL".
3. Range: MANUAL/AUTO
4. Polarity: Automatic positive and negative polarity display
5. Operating temperature and humidity: 0°C ~ 30°C (no more than 80% RH), 30°C ~ 40°C (no more than 75% RH), 40°C ~ 50°C (no more than 45% RH)
6. Storage temperature and humidity: -20°C ~ +60°C (no more than 80% RH)
7. Operating altitude: 0 ~ 2,000 m
8. Batteries in the unit 3 type 1.5V AAA alkaline batteries
9. If low batteries: LCD display " symbol ELIT 364B or " symbol ELIT 364, 365, W254
10. Overall dimensions: 235×83×47 mm
11. Weight: 338 g (including batteries)
12. Electromagnetic compatibility:
 - Under 1V/m radio-frequency field: Total accuracy = specified accuracy + 5% of range, the indicator is not specified for the radio-frequency field of 1V/m and more.
13. Appraisal: CE, GS, TÜV

VII. Overall Configuration

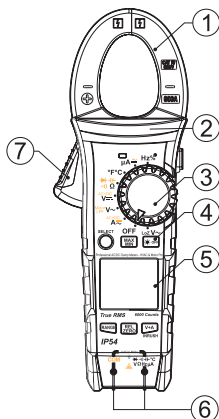

1. Jaw

It is the sensing device for measuring direct current, enabling to convert current to voltage.

2. Clamp body

It is a safe design to prevent the hand of the user from getting contact with the dangerous area.

3. Rotary switch

It is used to select the function stall for measuring.

4. Function key

It is used to select basic features

5. LCD display area

It displays the measured data and function symbol.

6. Measurement input terminals

It is used for the input of the measured signal.

7. Jaw trigger

Press the trigger to open the jaws; release the trigger to close the jaws automatically.

VIII. LCD Display

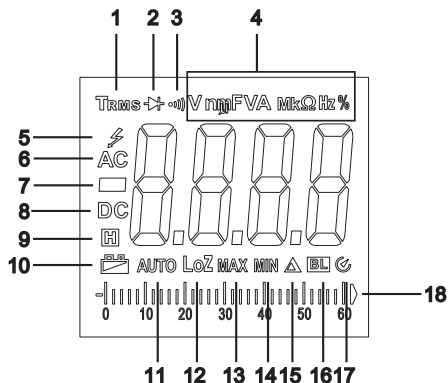

1. True root mean square prompt
2. Diode prompt
3. Circuit On/Off measuring prompt
4. Units prompt
5. High voltage alarm
6. AC signal prompt
7. Negative pole prompt
8. DC signal prompt
9. Holding symbol prompt
10. Low voltage prompt
11. AUTO range prompt
12. Low impedance measuring prompt
13. MAX measuring prompt
14. MIN measuring prompt
15. Relative Measurement prompt
16. Automatic backlight function prompt
17. Auto power off prompt
18. Analogue bar prompt

ELIT 364B

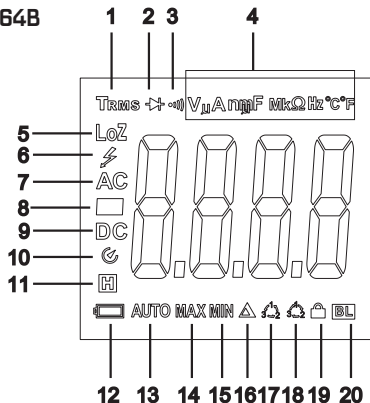

1. True root mean square prompt
2. Diode prompt
3. Circuit On/Off measuring prompt
4. Units prompt
5. Low impedance measuring prompt
6. High voltage alarm
7. AC signal prompt
8. Negative pole prompt
9. DC signal prompt
10. Auto power off prompt
11. Holding symbol prompt
12. Low voltage prompt
13. AUTO range prompt
14. MAX measuring prompt
15. MIN measuring prompt
16. Relative Measurement prompt
17. Motor reverse phase prompt
18. Motor positive sequence prompt
19. Phase sequence measuring lockout prompt
20. Automatic backlight function prompt

ELIT 365, W254

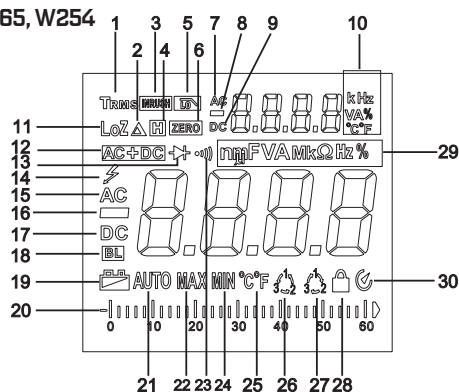

1. True root mean square prompt
2. Relative Measurement prompt
3. Surge current measurement prompt
4. Holding symbol prompt
5. Low pass measurement prompt
6. DC current resetting symbol
7. Secondary display AC prompt
8. Secondary display negative pole prompt
9. Secondary display DC signal prompt
10. Secondary display units prompt
11. Low impedance measuring prompt
12. AC+DC measuring prompt
13. Diode prompt
14. High voltage alarm
15. Main display AC signal prompt
16. Main display negative pole prompt
17. Main display DC signal prompt
18. Automatic backlight function prompt
19. Low voltage prompt
20. Analogue bar prompt

21. AUTO range prompt
22. MAX measuring prompt
23. Circuit On/Off measuring prompt
24. MIN measuring prompt
25. Temperature prompt
26. Motor reverse phase prompt
27. Motor positive sequence prompt
28. Phase sequence measuring lockout prompt
29. Main display units prompt
30. Auto power off prompt

IX. Knobs

ELIT 364 knob picture

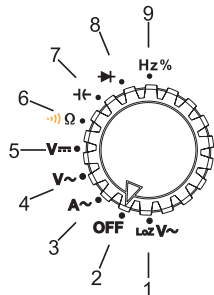

1. Low impedance AC voltage position
2. Meter OFF position
3. AC current position
4. AC voltage position
5. DC voltage position
6. Resistance position, continuity test position (Shortly press SELECT key for selection)
7. Capacitance position
8. Diode position
9. Frequency position and duty ratio position (Shortly press Hz% key for selection)

ELIT 364B knob diagram

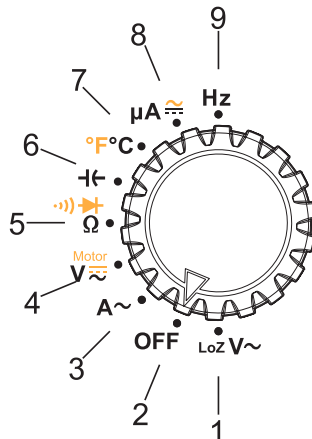

1. Low impedance AC voltage position
2. Meter OFF position
3. AC current position
4. AC/DC voltage position (Shortly press SELECT key for selection) and motor phase sequence measuring position (Press down and hold SELECT key for selection)
5. Resistance position continuity test position (Shortly press SELECT key for selection)
6. Capacitance position
7. Celsius and Fahrenheit position (Shortly press SELECT key for selection)
8. AC/DC microampere position (Shortly press SELECT key for selection)
9. Frequency position

ELIT 365, W254 knob diagram

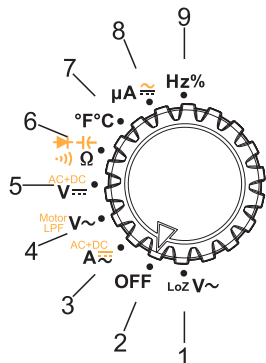

1. Low impedance AC voltage position
2. Meter OFF position
3. AC current, DC current position and AC+DC current position (Shortly press SELECT key for selection)
4. AC voltage position and low pass filter (LPF) position (Shortly press SELECT key for selection) and motor phase sequence measuring position (Press down and hold SELECT key for selection in AC voltage mode)
5. DC voltage position and AC+DC voltage position (Shortly press SELECT key for selection)
6. Resistance position, capacitance position and continuity test position (Shortly press SELECT key for selection)
7. Celsius and Fahrenheit position
8. AC/DC microampere position (Shortly press SELECT key for selection)
9. Frequency position and duty ratio position

X. Buttons

1. RANGE

Press RANGE button once to enter MANUAL measurement mode and change the range. Press RANGE button for 2 seconds and more to change from Manual range to Auto range. This is only valid for AC/DC voltage, AC/DC current, resistance, capacitance (excluding ELIT 364) and frequency measurement.

2. MAX/MIN

Press MAX/MIN button once, LCD will display "MAX" symbol, enter the MAX measurement mode and display the maximum value, if press it again, the LCD will display "MIN" symbol, enter the MIN measurement mode and display the minimum value. Repeat in this order. Press this button for at least 2 seconds to exit the MAX/MIN measurement. This is only valid for AC/DC voltage, AC/DC current, resistance, temperature, capacitance measurement on main display.

3. REL/ZERO

- Press REL button once to enter MANUAL range mode, LCD will display "▲" symbol and take the existing displayed values as reference, then it displays the difference between the measured value and the referential values. This is only valid for measurement of AC/DC voltage, AC/DC current, resistance, capacitance (excluding ELIT 364) and frequency.

- In DC range measuring, AC+DC current measuring and DC V+A mode, quickly press once to enter reset mode, the LCD will display “ZERO” symbol, pressing it again exits the reset mode. ELIT 365, W254

4. HOLD button: (suitable to full range)

Press this button once, the displayed values will be locked and held, LCD will display “” prompt, if press it again, the locking is released and enters normal measurement mode. This is suitable for full range.

5. A-OFF

It turns off the auto backlight function, if restart is required, rotate the function switch to OFF position to turn it on again.

6. V+A/INRUSH (only for ELIT 365, W254)

- In DC current DCA mode, pressing “V+A” button turns on the double display mode: Main display: DCA, secondary display: DCV, RANGE button and MAX/MIN button become invalid in this mode, pressing it again exits “V+A” mode.
- In AC current ACA mode, pressing “V+A” button turns on the double display mode: Main display: ACA, secondary display: ACV, RANGE button and MAX/MIN button become invalid in this mode, pressing it again exits “V+A” mode.
- In AC current ACA mode, press down and hold the “INRUSH” button to enter the inrush current measurement double display mode: Main display indicates inrush current value, secondary display indicates stable operating current value, pressing

and holding the “INRUSH” button again exits the inrush current measurement mode.

7. Hz% (Only for ELIT 364)

In AC voltage/AC current measurement mode, press “Hz%” button once to enter frequency measurement mode, press “Hz%” button again to enter Duty Ratio mode.

In Frequency/Duty Ratio measurement mode, press “Hz%” button once to enter Duty Ratio measurement mode, press “Hz%” button again to enter frequency mode.

8. Hz (Only for ELIT 364B)

Press “Hz” once to enter frequency measurement mode, press “Hz” button again to exit frequency measurement mod. The AC current measuring is valid only in AC voltage mode.

9. SELECT

- Press SELECT button once to select combined function of the position.
- In ACV mode, press down and hold SELECT button (at least 2 seconds) to start the Motor phase sequence measuring function, the main display indicates the rotation direction of the motor, the secondary display indicates the operating frequency; in case of resetting the Motor measurement function, press SELECT button once to start phase sequence measuring; press down and hold SELECT button (at least 2 seconds) to exit Motor function. (ELIT 365, W254)
- In ACV mode, press down and hold SELECT button (at least 2 seconds) to start the Motor phase sequence measuring function; press down and hold SELECT button (at least 2 seconds) to exit Motor function. (ELIT 364B)
- Pressing and holding SELECT button while turning the unit on cancels Auto-OFF function.

XI. Operating Instruction for Double Display Function

1. AC+DC function (ELIT 365, W254)

- Shortly pressing SELECT button in DCV mode can start AC+DC mode: The main display indicates AC+DC values; the secondary display will automatically switchover to indicate ACV value or DCV value with an interval of 2s.
- Shortly pressing SELECT button in DCA mode can start AC+DC mode: The main display indicates AC+DC values; the secondary display will automatically switchover to indicate ACA value or DCA value with an interval of 2s.



2. Voltage low pass filter measurement function
In ACV mode, the main display indicates ACV value, the secondary display indicates default frequency; shortly press "SELECT" button to enter Low Pass Filter function, the main display indicates voltage value, the secondary display indicates the frequency.

3. Rotation direction of motor

- In ACV mode, press down and hold SELECT button at least 2 seconds to start the Motor rotation direction function, the main display indicates the voltage value at that moment, the secondary display indicates the operating frequency; in case of resetting the Motor measurement function, shortly press SELECT button once to restart phase sequence measuring (for ELIT 364B, it is necessary to exit the Motor function and reenter to start the testing); press down and hold SELECT button (at least 2 seconds) to exit Motor function.

- Operating procedure: (Test condition: the frequency is 40 Hz ~ 80 Hz in case of AC 80V and more, it will keep on waiting if this range is exceeded)
 - a. In ACV mode, pressing down and holding SELECT button for at least 2 seconds automatically jumps to 600.0V range and wait for input signal, it will keep on waiting if there is no input.
 - b. After the first phase sequence is measured and locked, insert the other probes within 5 seconds, if the LCD displays 1→2→3, it indicates positive sequence; if the LCD displays 3→2→1, it indicates reverse sequence. If any signal is not input without moving the probe, it will time out in 5 seconds.
 - c. Press SELECT button for at least 2 seconds to exit Motor function.
- 4. INRUSH current measurement
In ACA mode, pressing down and holding "INRUSH" button enters inrush current measurement mode, when clamping the jaws into the conductor to be tested in the motor, the display is in waiting mode if there is no signal, after the motor starts, the main display will indicate the inrush current value, the secondary display will indicate the stable operating current after inrush.
- 5. Current and voltage simultaneous measuring
 - In DC current DCA mode, pressing "V+A" button turns on the double display mode: Main display: DCA; secondary display: DCV, when pressing it again, exit current and voltage simultaneous measuring.
 - In AC current (ACA) mode, press "V+A" button to start double display mode: Main display: ACA, secondary display: ACV; pressing it again exits current and voltage simultaneous measurement mode.

XII. Operating Instruction for Measuring

First, inspect 3 type 1.5V AAA batteries in the unit, if the instrument is turned on with low batteries, the screen will display “” symbol (ELIT 364B) or “” symbol (365, W254), it can be used only after the batteries are replaced. Attention should also be paid to the symbol “” beside the probe sockets, this is to warn you of not exceeding the indicated number for the voltage to be tested so as to guarantee the safety of testing!

1. Direct-current measurement

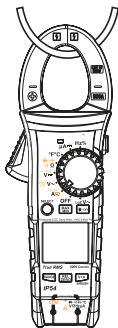

- 1) Set the switch to “A \sim ” (ELIT 364, 364B) or “A \square ” (365, W254) function position, press down and hold the trigger to open the jaws, clamp jaws on the conductor to be tested, then release the trigger slowly till the jaws are fully closed, please confirm whether the conductor to be tested is centrally clamped between the jaws,

Otherwise, additional error will be caused, only an individual current conductor can be measured once for the clamp meter, the measured readings will be erroneous if two or more current conductor are measured simultaneously.

- 2) Read the True Root Mean Square (RMS) and frequency values of AC current directly from the display (365, W254), for ELIT 364 it becomes necessary to press “HZ%” button to read the frequency and duty ratio, for ELIT 364B “HZ” button has to be pressed to read frequency value.
- 3) Press RANGE button to select 60A or 600A range, pressing down and holding “INRUSH” button enters inrush current measurement mode, when clamping the jaws into the conductor to be tested in the motor, the display is in waiting mode if there is no signal, after the motor starts, the main display will indicate the inrush current value, the secondary display will indicate the stable operating current after inrush (ELIT 365, W254)

The inrush current value is the first 100 mS current true root mean square from the trigger point, as shown in the picture below,

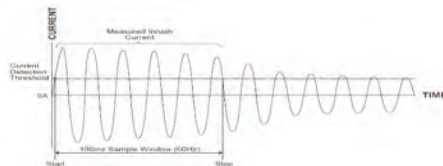

- the trigger value for inrush current at 60A range is 6A, 80A as the maximum.
the trigger value for inrush current at 600A range is 60A, 800A as the maximum.

- 4) Pressing “V+A” button enters current and voltage simultaneous measurement mode, the main display indicates AC current, and the secondary display indicates AC voltage. Pressing it again to exits Current and voltage simultaneous measurement mode (ELIT 365, W254)

⚠ Notes:

- The current measurement function should only be operated from 0°C to 40°C, in case of positive reading, the direction of current is from up to down (panel is up while bottom cover is down). Press down and hold the trigger without releasing it suddenly, as the Hall elements is a kind of sensitive devices, besides it is sensitive to magnetic, it also has different sensitivity to thermal and mechanical stresses, collision can results in reading change in short time.
- To guarantee the measured data to be accurate, the conductor to be tested should be located at the center of the jaws, otherwise an additional error of $\pm 1.0\%$ reading will be caused.

2. Direct-current measurement (only for 365, W254)

- 1) Set the switch to “ $\overline{A_{DC}}$ ” position, press SELECT button to select DC current range, when the LCD display is not zero, press REL to carry out zero clearing. After measuring in large current range, as the residual magnetism on the jaws will not disappear quickly, the LCD displays a background.
- 2) Press down and hold the trigger to open the jaws, clamp jaws on the conductor to be tested, then release the trigger slowly till the jaws are fully closed, please confirm whether the conductor to be tested is centrally clamped between the jaws,

otherwise an additional error will be caused, only an individual current conductor can be measured once for the clamp meter, the measured readings will be erroneous if two or more current conductor are measured simultaneously.

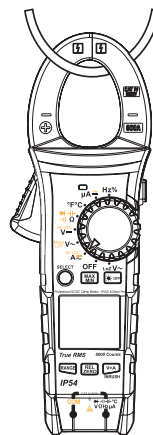

- 3) Read the value of DC current to be measured directly from the display.
- 4) Press “V+A” button to enter current and voltage simultaneous measurement mode, the main display indicates DC current, and the secondary display indicates DC voltage. Press it again to exit current and voltage simultaneous measurement mode.
- 5) In DC current mode, press “SELECT” button to select AC+DC function, the main display on the screen indicates AC+DC values; the secondary display will automatically switch over to indicate ACA value or DCA value with an interval of 2s.

⚠ Notes:

- The current measurement function should only be operated from 0°C to 40°C, in case of positive reading, the direction of current is from up to down (panel is up while bottom cover is down). Press down and hold the trigger without releasing it suddenly, as the Hall elements is a kind of sensitive devices, besides it is sensitive to magnetic, it also has different sensitivity to thermal and mechanical stresses, collision can results in reading change in short time.
- To guarantee the measured data to be accurate, the conductor to be tested should be located at the center of the jaws, otherwise an additional error of $\pm 1.0\%$ reading will be caused.

3. Direct-voltage measurement

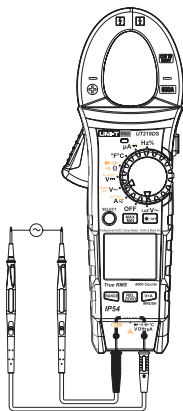

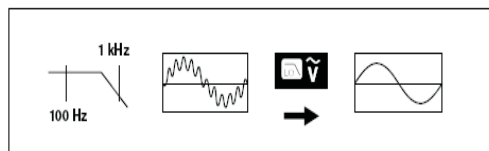

- 1) Insert the red probe into “V” socket; insert the black probe into “COM” socket.
- 2) Set the functional range switch to “V~” (ELIT 364) or “ $\sqrt{\text{Motor}}$ ” (ELIT 364B) or “ $\sqrt{\text{LPP}} \text{V}\sim$ ” (365, W254) select the measuring range of AC voltage, and parallelly connect the probes to the power supply or load to be measured.
- 3) Read the True Root Mean Square (RMS) and frequency values of AC voltage from the display (365, W254) , for ELIT 364 , it becomes necessary to press “HZ%” button to read the frequency and duty ratio, for UT219M, “HZ” button has to be pressed to read frequency value.
- 4) Press “SELECT” button to select Low Pass Filter function (365, W254) , this filter will measure and catch the voltage of 1KHz or more, as shown in the picture below, low pass filter can measure the combined sine wave signal generated by the inverter and variable frequency motor.



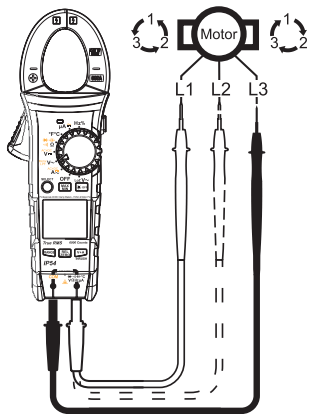

- 5) Set the functional range switch to “ $\sqrt{\text{Laz}} \text{V}\sim$ ” position, select low impedance AC voltage measurement, its resistance is about 300 k Ω , which can prevent the impact of the virtual voltage.

- 6) In AC voltage mode, press down and hold SELECT button to enter and turn on MOTOR phase rotation measurement function. ELIT 364B, 365, W254, LCD displays flashing locked symbol “”, which is waiting for input signal. As it is shown in following picture:



Fix the black probe at L3, the red probe will first measure L1, wait till the “” on the LCD is locked, change the red probe to L2 within 5 seconds, in this case the  symbol will be displayed on LCD, indicating forward rotation phase sequence.

Fix the black probe at L3, the red probe will first measure L2, wait till the “” on the LCD is locked, change the red probe to L1 within 5 seconds, in this case the  symbol will be displayed on LCD, indicating reverse phase sequence.

After completion of the measurement, short pressing SELECT button can restart the MOTOR measurement (only for 365, W254); pressing down and holding SELECT button for at least 2 seconds again will exit the MOTOR phase rotation measurement function.

⚠ Notes:

- 1) Phase sequence measuring condition, the frequency is 40 Hz ~ 80 Hz in case of AC 80V and more, the flashing “” symbol will display on LCD screen and it will keep on waiting if range of frequency response is exceeded.
- 2) A special filter circuit is built in the chip of 365, W254 product, which will filtrate the high-frequency interference signal, and suitable to the measurement in case of variable-frequency voltage. The lock time for measured phase sequence (approximate 10s more or less).
- 3) When carrying out measurement by using ELIT 364B product in variable frequency condition, due to the impact of multiple-harmonic PWM, the lock time for measured phase sequence is much slower (about 30s more or less), and the frequency range is just suitable from 50 Hz to 80 Hz, and it is possible that the unstable state of phase sequence measuring may occur.

⚠ Note:

- Do not input a voltage that is more than 600 Vrms. As there is the possibility to measure much higher voltage, but the risk to damage the instrument exists!

- In case of measuring high voltage, special attention should be paid to prevent the risk of electric shock!
- In low pass filter measurement mode, the instrument will automatically change to Manual mode, the range can be selected by pressing RANGE button.
- After completion of all measuring operation, disconnect the probes from the tested circuit.
- When the measured voltage is higher than 30V/AC safe voltage, the LCD of this instrument will display high voltage warning prompt “⚡”, in case of over-voltage input: when it is more than AC 1000V range, this instrument will automatically buzz intermittent sound and the high voltage warning prompt ⚡ will flash to prompt the warning!

4. Direct-voltage measurement.

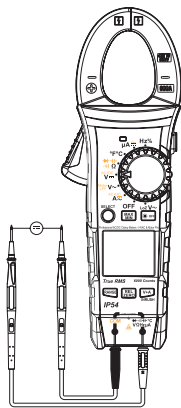

- 1) Insert the red probe into “V” socket; insert the black probe into “COM” socket.
- 2) Set the functional range switch to “ V_{DC} ” ELIT 364 or “ V_{DC} ” ELIT 364B or “ $V_{\text{AC+DC}}$ ” (365, W254) pressing SELECT button selects the measuring range of AC voltage, and parallelly connect the probes to the power supply or load to be measured.
- 3) Read the DC Voltage value from the display.
- 4) Press “SELECT” button to select AC+DC function, the main display on the screen indicates AC+DC values; the secondary display will automatically switchover to indicate ACA value or DCA value with an interval of 2s (365, W254)

⚠ Notes:

- Do not input a voltage that is more than 1000V As there is the possibility to measure much higher voltage, but the risk to damage the instrument exists!
- In case of measuring high voltage, special attention should be paid to prevent the electric shock.
- After completion of all measuring operation, disconnect the probes from the tested circuit.
- When the measured voltage is higher than 30V/DC safe voltage, the LCD of this instrument will display high voltage warning prompt “⚡”, in case of over-voltage input: when it is more than DC 1000V range, this instrument will automatically buzz intermittent sound and the high voltage warning prompt ⚡ will flash to prompt the warning!

6. DC microamp current measurement

ELIT 364B, 365, W254

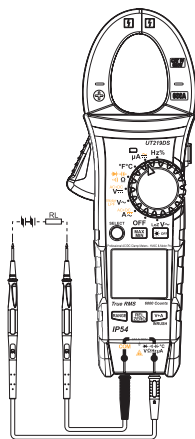

- 1) Insert the red probe into “ μA ” socket; insert the black probe into “COM” socket.
- 2) Set the functional range switch to “ μA ”, press SELECT button to select the measuring range of DC microampere current, and parallelly connect the probes to the power supply or load to be measured.
- 3) Read the DC microampere current value from the display.

⚠ Notes:

- Do not input DC or AC 30 V and more voltage to prevent from personal injury.
- After completion of all measuring operation, disconnect the probes from the tested circuit.

7. AC microampere current measurement

ELIT 364B, 365, W254

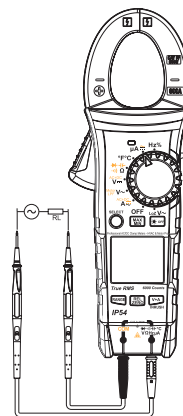

- 1) Insert the red probe into “ μA ” socket; insert the black probe into “COM” socket.
- 2) Set the functional range switch to “ μA ”, press SELECT button to select the measuring range of AC microampere current, and parallelly connect the probes to the power supply or load to be measured.
- 3) Read the true root mean square and frequency values of AC microampere current from the display ELIT 365, W254

⚠ Notes:

- Do not input DC or AC 30V and more voltage to prevent from personal injury.
- After completion of all measuring operation, disconnect the probes from the tested circuit.

8. Resistance measurement

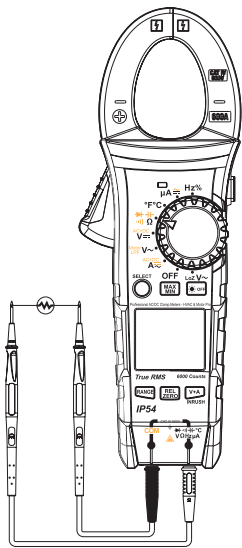

- 1) Insert the red probe into “ Ω ” socket; insert the black probe into “COM” socket.
- 2) Set the functional range switch to “ $\cdot \Omega$ ” (ELIT 364) or “ $\cdot \Omega \rightarrow$ ” (ELIT 364B) or “ $\cdot \Omega \rightarrow \rightarrow$ ” (365, W254) press SELECT button to select the measuring range of resistance, and parallelly connect the probes to both ends of the resistance to be measured.
- 3) Read the value of resistance to be measured directly from the display.

⚠ Notes:

- If the resistance to be measured is open circuit or the value of resistance is more than the maximum range of the instrument, the “OL” will be displayed.
- When measuring the on-line resistance, turn off all power supplies in the circuit to be measured and discharge all residual charges on all capacitors before carrying out measurement. In this way, the correct measuring can be assured.
- In case of low resistance measuring, there is an additional error of about 0.1Ω to 0.2Ω resistance. To obtain the precise reading, the relative measurement function can be used, first short circuit the input probes and press REL button, carry out low resistance measurement after the instrument has subject the indicated value when shorting circuit the probes.
- If the resistance value is not less than 0.5Ω when shortening circuit of probes, check for any loosening or other causes with the probes.
- When measuring high resistance, the reading will become stable after time duration of few seconds. This is normal for high resistance measuring.
- Do not input DC or AC 30 V and more voltage to prevent from personal injury.
- After completion of all measuring operation, disconnect the probes from the tested circuit.

9. Conductivity testing

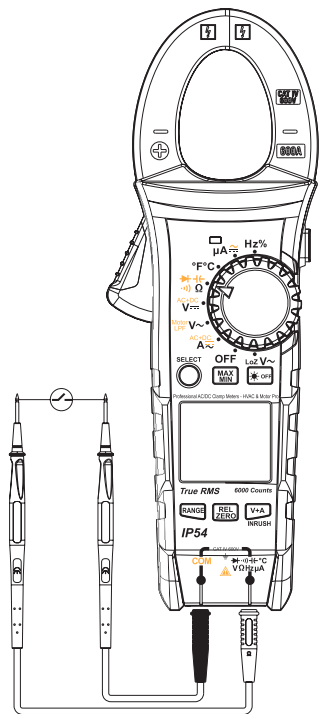

1) Insert the red probe into “ Ω ” socket, insert the black probe into “COM” socket.

- 2) Set the functional range switch to “ Ω ” (ELIT 364) or “ Ω \rightarrow ” (ELIT 364B) or “ Ω \rightarrow \rightarrow ” (ELIT 365, W254) press SELECT button to select the measuring range of resistance, and parallelly connect the probes to both ends of the load to be measured. If the resistance between both ends is less than 10Ω , the circuit is considered as breakover, the buzzer will sound continuously. In case the resistance is more than 50Ω , the buzzer will not give any sound.
- 3) Read the value of resistance value of load for the circuit to be measured directly from the display.

⚠ Notes:

- When inspecting the on-line circuit conductivity, turn off all power supplies in the circuit to be measured and discharge all residual charges on all capacitors before carrying out measurement.
- For circuit conductivity measuring, the open circuit voltage is about -3.2 V more or less, the range is 100Ω measurement.
- Do not input DC or AC 30 V and more voltage to prevent from personal injury.
- After completion of all measuring operation, disconnect the probes from the tested circuit.

10. Diode measuring

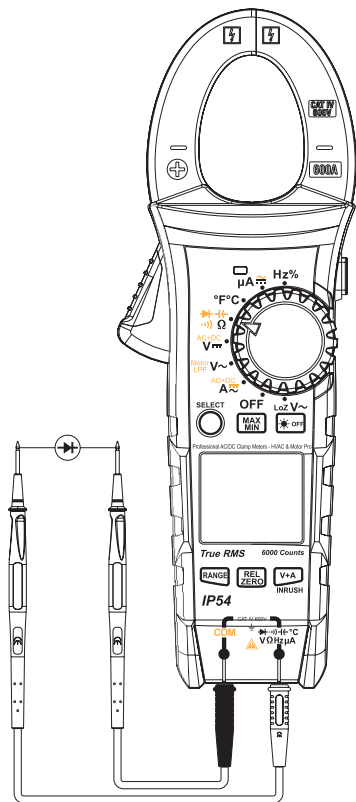

- 1) Insert the red probe into “+” socket, insert the black probe into “COM” socket. The polarity of the red probe is “+”, the polarity of the black probe is “-”.
- 2) Set the function switch to “▶|” (ELIT 364) or “◀|▶” (ELIT 364B) or “◀|▶|◀” (365, W254) measurement position, press SELECT button to select diode measurement ▶|, read the positive PN-junction voltage of the diode to be measured directly from the display. For silicon PN-junction, it will be confirmed to be normal value if the reading is about 500 to 800 mV.

⚠ Notes:

- If the diode to be measured is open circuit or the polarity is reverse, “OL” will be displayed.
- When measuring the on-line diode, turn off all power supplies in the circuit to be measured and discharge all residual charges on all capacitors before carrying out measurement.
- The open circuit voltage of diode in (ELIT 364) is about 10 V more or less, voltage value for voltage stabilizing diode can be measured (less than 9 V). The open circuit voltage of diode in (ELIT 364B) and (365, W254) is 3.2 V more or less.
- Do not input DC or AC 30V and more voltage to prevent from personal injury.
- After completion of all measuring operation, disconnect the probes from the tested circuit.

11. Capacitance measurement

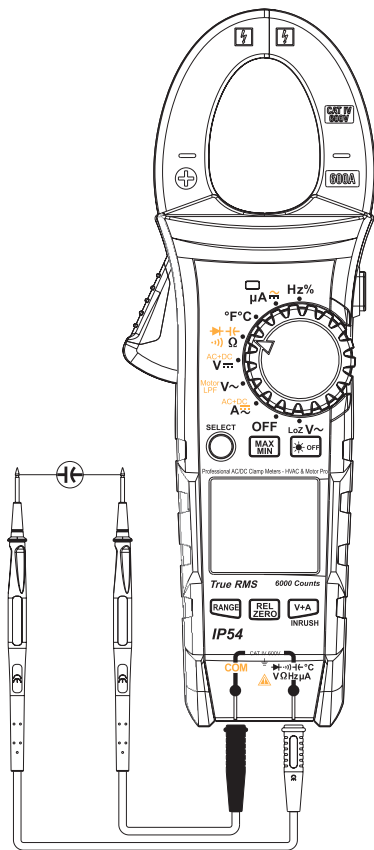

- 1) Insert the red probe into “ Ω ” socket, insert the black probe into “COM” socket.
- 2) Set the range switch to “ Ω ” (ELIT 364, 364B) or “ Ω \rightarrow Ω ” (365, W254) measurement position, press SELECT button to select the measuring range of resistance, and parallelly connect the probes to both ends of the resistance to be measured.
- 3) Read the value of capacitance value of load for the circuit to be measured directly from the display.

⚠ Notes:

- If the capacitance to be measured is short circuit or the value of capacitance is more than the maximum range of the instrument, the “OL” will be displayed.
- In the capacitance measurement mode, the cursor of analog bar is deactivated. For the measurement of capacitance of more than 600 μF, it will take much longer time so as to generate correct reading.
- For the purpose of guaranteeing the measurement resolution, it is suggested to fully discharge the residual charges before measuring, then connect with the instrument for measurement, this is much more important for high voltage capacitance to prevent the instrument from being damaged and personal injury.
- After completion of measuring operation, disconnect the probes from the tested capacitance.

12. Frequency/duty ratio measurement

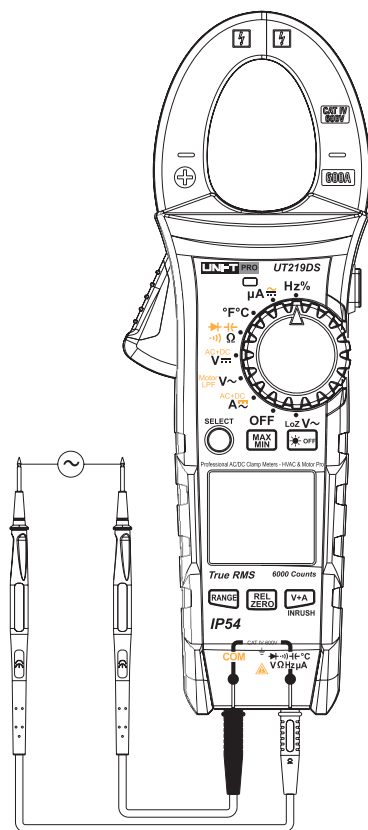

- 1) Insert the red probe into “Hz” socket; insert the black probe into “COM” socket.
- 2) Set the functional range switch to “Hz” (ELIT 364B) or “Hz%” (ELIT 364, 365, W254) measurement position, parallelly connect the probes to the signal source to be measured.
- 3) Read the value of frequency and duty ratio (365, W254) to be measured directly from the display. In case of ELIT 364, press “Hz%” button once to enter Duty Ratio measurement mode, press “Hz%” button again to enter frequency measurement mode.

⚠ Note:

- The requirement for input amplitude (a) should be met in frequency measurement:
 - ≤100 kHz: $200 \text{ mVrms} \leq a \leq 20 \text{ Vrms}$
 - >100 kHz~1 MHz: $600 \text{ mVrms} \leq a \leq 20 \text{ Vrms}$
 - >1 MHz~10 MHz: $1 \text{ Vrms} \leq a \leq 20 \text{ Vrms}$
 - >10 MHz: $1.8 \text{ Vrms} \leq a \leq 20 \text{ Vrms}$
- Following requirements should be satisfied in duty ratio measurement:
 - The waveform is square wave, and frequency $\leq 10 \text{ kHz}$
 - the amplitude: $2 \text{ Vpp} \leq \text{Input amplitude} \leq 20 \text{ Vpp}$
- Do not input 30 Vrms and more voltage for the frequency to be measured to prevent from personal injury.
- After completion of all measuring operation, disconnect the probes from the tested circuit.

13. Temperature measurement (ELIT 364M, 365, W254)

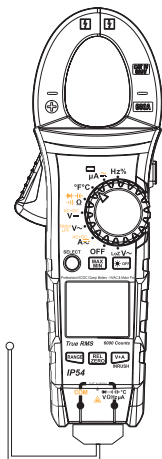

- 1) Set the range switch to “C/°F” position, in this case the LCD displays “OL”, and display room temperature by shorting circuit the probes.
- 2) Insert the type K temperature plug into the socket position as shown in the picture.
- 3) Use the temperature probe to detect the surface to be measured, the measured Celsius value and Fahrenheit value can be read directly from the LCD (ELIT 365, W254) in case of (ELIT 364B) it becomes necessary to press SELECT button to display Fahrenheit.

⚠ Notes:

- The ambient temperature for the instrument should not exceed a range of 18 to 28°C, otherwise measuring error will be caused, which becomes much more significant when measuring in low temperature environment.
- Do not input DC or AC 30 V and more voltage to prevent from personal injury.
- After completion of all measuring operation, remove the temperature probe.

12. Other functions

● Auto-Shutoff function:

If any knob switch is not operated or any button is not pushed within about 15 minutes, the instrument will turn on the auto-shutoff function to save energy. In the auto power off state, click any button or turn the knob switch, the instrument will be waken up automatically.

The auto-shutoff feature will be canceled when powering on again after pressing SELECT button in shutdown state. It will be necessary to restart the unit to restore the Auto-off function.

● Auto backlight:

In case the instrument is placed in a dark environment after turning it on, the backlight function will be turned on immediately. If the instrument is placed in a bright environment again, the backlight function will be turned off in 30 seconds.

In addition, the auto backlight function will be turned off after pressing OFF button while the backlight is on, if it is necessary to restart the backlight function, just turn off the unit and turn it on again.

- Low voltage testing: Detect the internal VDD while the power is supplied, when it is less than 3 V, “” low battery symbol will be displayed.

XIII. Technical specifications

Accuracy: $\pm(a\% \text{ reading} + b \text{ digit})$, the warranty period is one year.

Ambient temperature: 23°C to 5°C (73.4°F \pm 9°F)

Relative humidity: $\leq 75\%$

 Note:

Accurate temperature condition is 18°C to 28°C, the ambient temperature fluctuation range is stable in $\pm 1^\circ\text{C}$. If the temperature $< 18^\circ\text{C}$ or $> 28^\circ\text{C}$, the additional temperature coefficient error is $0.1 \times (\text{specified accuracy})/^\circ\text{C}$.

1. AC current

Range	Resolution	Accuracy		Overload protection
		40Hz~100Hz	100Hz~400Hz	
60.00A	0.01A	$\pm(1.8\%+6)$	$\pm(3.5\%+6)$	600A
600.0A	0.1A			

- Display: True root mean square: Suitable to a range of 5% to 100%.
- Frequency response: 40 Hz~400 Hz, frequency measurement is suitable to a range of 10% to 100%.
- The AC wave peak factor is up to 3.0 in full value, the accuracy of non-sine wave should be adjusted based on following conditions:
Wave peak factor 1.0 to 2.0 The accuracy should be increased by 3.0%
Wave peak factor 2.0 to 2.5 The accuracy should be increased by 5.0%
Wave peak factor 2.5 to 3.0 The accuracy should be increased by 7.0%
- The accuracy of inrush current is 10%, this is just for reference

2. DC current (ELIT 365, W254)

Range	Resolution	Accuracy	Overload protection
60.00A	0.01A	$\pm(1.8\%+6)$	600A
600.0A	0.1A		

- Press ZERO key for resetting the background figure

3. AC+DC current (ELIT 365, W254)

Range	Resolution	Accuracy		Overload protection
		40Hz~100Hz	100Hz~400Hz	
60.00A	0.01A	$\pm(3.0\%+6)$	$\pm(4.5\%+6)$	600A
600.0A	0.1A			

- The AC current is true root mean square, and suitable to a range of 5% to 100%.
- AC frequency response: 40 Hz~400 Hz,
- The AC wave peak factor is up to 3.0 in full value, the accuracy of non-sine wave should be adjusted based on following conditions:
Wave peak factor 1.0 to 2.0 The accuracy should be increased by 3.0%
Wave peak factor 2.0 to 2.5 The accuracy should be increased by 5.0%
Wave peak factor 2.5 to 3.0 The accuracy should be increased by 7.0%
- Press ZERO key for resetting the background figure of DC current
- AC+DC (AC is combined with DC) is defined as $\sqrt{ac^2+dc^2}$

4. AC voltage

Range	Resolution	Accuracy	Overload protection
6.000V	0.001V	± (1.0%+6)	1000V DC 1000V AC
60.00V	0.01V		
600.0V	0.1V		
1000V	1V		

- Input impedance: the input impedance is about 10 M Ω .
- Display true root mean square, suitable to a range of 5% to 100%.
- Frequency response: 40 Hz~400 Hz (ELIT 364, 364B) 40Hz~1kHz (365, W254) the frequency measurement is suitable to a range of 10% to 100%.
- The AC wave peak factor is up to 3.0 in full value (except 600 V range, 1.5 in case of this full range value) for non-sine waveform, the accuracy of non-sine wave should be adjusted based on following conditions:
 - Wave peak factor 1.0 to 2.0 The accuracy should be increased by 3.0%
 - Wave peak factor 2.0 to 2.5 The accuracy should be increased by 5.0%
 - Wave peak factor 2.5 to 3.0 The accuracy should be increased by 7.0%

5. Motor AC voltage

Range	Resolution	Accuracy	Overload protection
600.0V	0.1V	± (2.0%+7)	1000V DC 1000V AC

- Input impedance: the input impedance is about 10 M Ω .
- Under the condition of variable frequency power supply, the measured voltage value is only for reference!
- Display true root mean square, suitable to a range of 5% to 100%.
- AC frequency response: 40Hz~80Hz
- The AC wave peak factor is up to 3.0 in full value (except 1000V range, 1.5 in case of this full range value) for non sine waveform, the accuracy of non sine wave should be adjusted based on following conditions:
 - Wave peak factor 1.0 to 2.0 The accuracy should be increased by 3.0%
 - Wave peak factor 2.0 to 2.5 The accuracy should be increased by 5.0%
 - Wave peak factor 2.5 to 3.0 The accuracy should be increased by 7.0%

6. LoZ AC voltage

Range	Resolution	Accuracy	Overload protection
600.0V	0.1V	± (2.5%+6)	1000V DC 1000V AC

- Input impedance: the input impedance is about 300 k Ω .
- Display true root mean square, suitable to a range of 5% to 100%.
- Frequency response: 40Hz~400Hz ELIT 364, 40Hz ~1kHz (365, W254) the frequency measurement is suitable to a range of 10% to 100%.

- The AC wave peak factor is up to 1.5 in full value, the accuracy of non-sine wave should be adjusted based on following conditions:
Wave peak factor 1.0 to 2.0 The accuracy should be increased by 3.0%
Wave peak factor 2.0 to 2.5 The accuracy should be increased by 5.0%
Wave peak factor 2.5 to 3.0 The accuracy should be increased by 7.0%
- The measuring time should not exceed 1 minute

7. DC voltage

Range	Resolution	Accuracy	Overload protection
600.0mV ELIT 364	0.1mV	$\pm (0.8\%+3)$	1000V DC 1000V AC
6.000V	0.001V	$\pm (0.6\%+3)$	
60.00V	0.01V	$\pm (0.9\%+6)$	
600.0V	0.1V		
1000V	1V		

- Input impedance: the input impedance is about 10 M Ω

8. AC+DC voltage ELIT 365, W254

Range	Resolution	Accuracy	Overload protection
6.000V	0.001V	$\pm (2.0\%+5)$	1000V DC 1000V AC
60.00V	0.01V		
600.0V	0.1V		
1000V	1V		

- Input impedance: the input impedance is about 10M Ω .
- Display true root mean square of AC voltage, suitable to a range of 5% to 100%.
- AC frequency response: 40 Hz~400 Hz
- The AC wave peak factor is up to 3.0 in full value (except 1000V range, 1.5 in case of this full range value) for non sine waveform, the accuracy of non sine wave should be adjusted based on following conditions:
Wave peak factor 1.0 to 2.0 The accuracy should be increased by 3.0%
Wave peak factor 2.0 to 2.5 The accuracy should be increased by 5.0%
Wave peak factor 2.5 to 3.0 The accuracy should be increased by 7.0%
- AC+DC (AC is combined with DC) is defined as

$$\sqrt{v_{ac}^2 + v_{dc}^2}$$

9. Resistance measurement

Range	Resolution	Accuracy	Overload protection
60.00 Ω 365, W254	0.01 Ω	$\pm (1.5\%+3)$	1000V DC 1000V AC
600.0 Ω	0.1 Ω	$\pm (1.3\%+3)$	
6.000k Ω	1 Ω	$\pm (1.0\%+3)$	
60.00k Ω	10 Ω		
600.0k Ω	100 Ω		
6.000M Ω	1k Ω	$\pm (1.6\%+4)$	
60.00M Ω	10k Ω	$\pm (2.6\%+7)$	

10. Conductivity test (••)

Range	Resolution	Accuracy	Overload protection
600.0Ω (ELIT 364)	0.1Ω (ELIT 364)	The buzzer will give a sound in case of less than 50 Ω, and will not give a sound in case of more than 50 Ω	1000V DC 1000V AC
60.00 (ELIT 364B)	0.01Ω (ELIT 364B)		
99.99Ω (365, W254)	0.01Ω (365, W254)	Open-circuit voltage is about 3 V	

11. Diode measuring (▶)

Range	Resolution	Accuracy	Overload protection
6.000V (ELIT 364B)	0.001V	Open-circuit voltage for ELIT 364 is about 10 V, the voltage value for voltage stabilizing diode can be measured (less than 9 V), the open circuit voltage of diode in ELIT 364B or 365, W254 is 3.2V more or less, which can measure the PN junction with the positive voltage drop of 3 V and less. The normal voltage value for Silicon PN junction is about 0.5 to 0.8 V.	1000V DC 1000V AC
6.000V (365, W254)			
6.000V/ 10.00V (ELIT 364)			

12. Capacitance measurement

Range	Resolution	Accuracy	Overload protection
6.000nF (ELIT 364B)	0.001nF	± (4.0%+30) (ELIT 364) ± (4.0%+7) (ELIT 364B) ± (4.0%+7) (365, W254)	1000V DC 1000V AC
60.00nF	0.01nF		
600.0nF	0.1nF	± (4.0%+7)	
6.000uF	0.001uF		
60.00uF	0.01uF		
600.0uF	0.1uF	± 10%	
6.000mF	0.001mF		
60.00mF	0.01mF		

In case of capacitance to be measured $\leq 1\mu\text{F}$, it is suggested that the accuracy of measurement can be guaranteed only by using the REL measurement mode.

13. Frequency

Range	Resolution	Accuracy	Overload protection
60.00Hz~10.00MHz (ELIT 364)	0.01Hz~ 0.01MHz	± (0.1%+6)	1000V DC 1000V AC
60.00Hz~40.00MHz (ELIT 364B)			
60.00Hz~40.00MHz (365, W254)			

The requirement for input amplitude (a) should be met in frequency measurement:
 $\leq 100\text{ kHz}$: $200\text{ mVrms} \leq a \leq 30\text{ Vrms}$
 $> 100\text{ kHz} \sim 1\text{ MHz}$: $600\text{ mVrms} \leq a \leq 30\text{ Vrms}$
 $> 1\text{ MHz} \sim 10\text{ MHz}$: $1\text{ Vrms} \leq a \leq 30\text{ Vrms}$
 $> 10\text{ MHz}$: $1.8\text{ Vrms} \leq a \leq 30\text{ Vrms}$

14. Duty ratio measurement (ELIT 364, 365, W254)

Range	Resolution	Accuracy	Overload protection
0.1%~99.9%	0.1%	$\pm (2.6\%+7)$	1000V DC 1000V AC

Following requirements should be satisfied in duty ratio measurement:

The waveform is square wave, and frequency $\leq 10\text{kHz}$

the amplitude: $2 V_{pp} \leq \text{Input amplitude} \leq 30V_{pp}$

Frequency $\leq 1\text{ kHz}$, Duty: 5.0%-95.0%

Frequency $>1\text{ kHz}$, Duty: 30.0%-70.0%

15. Temperature measurement (ELIT 364B, 365, W254)

Range			Resolution	Accuracy	Overload protection
°C	-40~ 1000°C	-40~0°C	1°C	$\pm 5^\circ\text{C}$	1000V DC 1000V AC
		>0~600°C		$\pm (2.0\%+5^\circ\text{C})$	
		>600~ 1000°C		$\pm (2.5\%+5^\circ\text{C})$	
°F	-40~ 1832°F	-40~32°F	1°F	$\pm 9^\circ\text{F}$	
		>32~ 1112°F		$\pm (2.0\%+9^\circ\text{F})$	
		>1112~ 1832°F		$\pm (2.5\%+9^\circ\text{F})$	

Remarks: The point K type (nickel-chromium ~ nickel-silicon) thermocouple provided for the accessories is only suitable to the measurement of 230°C/446°F and less temperature.

XIV. Maintenance and Repair

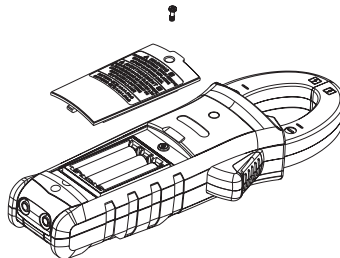

⚠ Warning: Remove the test probes before opening the bottom cover in order to prevent from electric shock.

- General maintenance
 - The repair and service of this clamp meter should be carried out by qualified professional maintenance staff or authorized repair department.
 - Clean the case regularly with dry cloth, but it is not allowed to use the cleaning agent containing lapping compound or solvent component.
- Installation or replacement of batteries

The power supply for this product is 3 type AAA 1.5V batteries, please install or replace the batteries by following order:

 - Shut down this product, remove the test probes at input end.
 - With panel of this product facing down, unscrew the battery box screws and pull out the cover, take out the batteries, install the new batteries according to the indication of the polarities.
 - Please use the batteries of the same type, do not install any improper batteries.
 - After installing new batteries, put back the battery cover and fix it with screws.



ELIT AS
Hellenvegen 9
2022 GJERDRUM
NORWAY

ELIT AS www.elit.no
Telephone : +47 63 93 88 80
E-mail: firmapost@elit.no

Innhold i denne manual kan forandres uten forvarsel
Vi tar forbehold om eventuelle trykkfeil